

# SM512 Series Fiber Optic Mode Sensor

Model SM512LBFO DC sensor with metal housing



Banner fiber optic sensor model SM512LBFO is designed for reliable performance in especially hostile industrial environments. It has totally-encapsulated circuitry within a die-cast metal housing for superior resistance to moisture and physical abuse. It is used with Banner glass fiber optic assemblies in the opposed, retroreflective, and diffuse fiber optic sensing modes.

The narrow, 1/2" wide housing design has gained this family of sensors the nickname of "the flatpack". Like the MINI-BEAM, this design allows multiple SM512 Series sensors to be easily stacked together side-by-side on 1/2" centers for use in tight locations.

SM512 Series sensors have *complementary* NPN transistor outputs (one normally open and the other normally closed), which connect directly to Banner MICRO-AMP and MAXI-AMP logic modules, as well as to most logic gates, small relays, and other similar dc loads.



## SPECIFICATIONS, SM512LBFO Sensor

**RANGE:** See page 2. **SENSING BEAM:** 940 nm (infrared).

**SUPPLY VOLTAGE:** 10-30V dc. Maximum allowable ripple 10%; supply current is typically less than 40mA (exclusive of load).

**OUTPUT CONFIGURATION:** Complementary open-collector NPN transistors (one normally open and one normally closed), with continuous short-circuit protection. Reverse polarity protection.

**OUTPUT RATING:** Each output transistor is capable of sinking up to 250mA continuously. On-state saturation voltage less than 2 volts at full load and less than 1 volt at signal levels. Off-state leakage current less than 100 microamps. Outputs are reverse-polarity protected.

**RESPONSE TIME:** 1 millisecond. Response time is independent of signal strength.

**REPEATABILITY:** 0.3 millisecond. Repeatability is independent of signal strength.

**OPERATING TEMPERATURE:** -40 to +70 °C (-40 to +158 °F).

**CONSTRUCTION:** Die-cast metal housing with stainless steel legend plate. Totally encapsulated. NEMA 1, 2, 3, 3S, 4, 4X, 12, and 13. Cables are .15-inch diameter, PVC covered, and shielded (4 conductor, 6 feet long).

**INDICATOR LED:** Red LED indicator at rear of sensor (above cable exit) lights when the sensor is receiving a "light" signal.

**SENSITIVITY ADJUSTMENT:** Single-turn adjustment, accessible by removing the nylon screw on the side of the sensor.

### APPLICATION WARNINGS:

Outputs will not directly interface TTL logic, due to the reverse-polarity protection diode. Contact the factory for TTL interfacing instructions.

The short-circuit protection may de-energize the outputs with certain incandescent light bulb or capacitive loads. Contact the factory if these loads are anticipated.

## Dimension Drawing

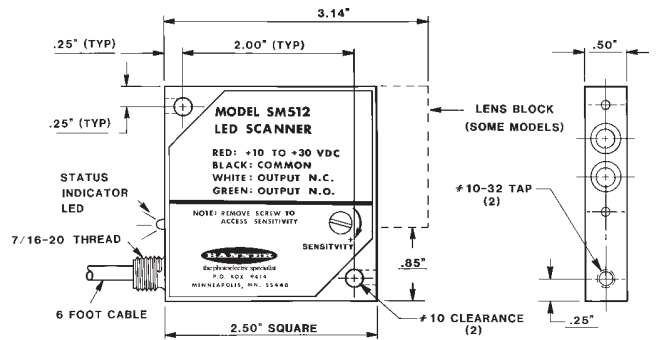

## Functional Schematic

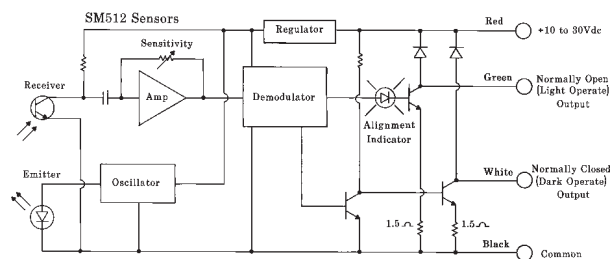

**WARNING** These photoelectric presence sensors do NOT include the self-checking redundant circuitry necessary to allow their use in personnel safety applications. A sensor failure or malfunction can result in *either* an energized or a de-energized sensor output condition.

Never use these products as sensing devices for personnel protection. Their use as safety devices may create an unsafe condition which could lead to serious injury or death.

Only MACHINE-GUARD and PERIMETER-GUARD Systems, and other systems so designated, are designed to meet OSHA and ANSI machine safety standards for point-of-operation guarding devices. No other Banner sensors or controls are designed to meet these standards, and they must NOT be used as sensing devices for personnel protection.

# SM512LBFO Fiber Optic Sensors

## SM512LBFO

**Opposed fiberoptic, Retroreflective fiberoptic, and Diffuse fiberoptic modes**

**VOLTAGE:** 10-30V dc

**RANGE:** opposed, retroreflective, and proximity modes. See excess gain curves.

**RESPONSE TIME:** 1 millisecond

**REPEATABILITY:** 0.3 millisecond

**SENSING BEAM:** infrared, 940nm



Model **SM512LBFO** may be used with the full range of Banner glass fiberoptic assemblies for sensing in the fiberoptic opposed, retroreflective, and proximity modes. The small size and fast response time of this sensor make it suitable for most fiberoptic sensing applications.

In the **opposed mode**, the sensing range is up to 10 inches using 1/8-inch diameter fiber bundles, or up to 4 inches using 1/16-inch diameter bundles (used when very small-diameter effective beams are required). With the addition of the L9 or L16F lens, these ranges are increased to 60 and 300 inches, respectively. (The absolute maximum range is, as always, limited by the lengths of the fibers themselves.)

**Retroreflective sensing** employs the bifurcated (branched) fiber model BT13S along with either the L9 or L16F lens. Notice from the excess gain curves that the excess gain is at its maximum when the target is close to the lens. This is in contrast to most retroreflective sensors, in which the excess gain falls off dramatically at close ranges, and is due to the inherent coaxial nature of the fiber bundles. Retroreflective sensing is also possible using fibers without lenses, but in this mode the fiber will reflect light directly off of objects that are in the "proximity" range of the fiber, typically the first inch from the end of the fiber. Also, the sensing range to a retroreflective target is greatly reduced when a lens is not used (generally to less than 3 feet with a 3-inch diameter reflector and to less than 1 foot using retroreflective tape).

The most commonly used fiberoptic sensing mode is the **diffuse mode**, due to the ease with which fibers may be configured to sense small parts in automatic assembly machines, vibratory feeders, small conveyors, and other "one side only" applications. Lenses are *not* recommended to extend the sensing range of fibers in the proximity mode, since internal reflections from the back of the lens can cause false operation. If more range is necessary, it is best to use two individual fibers converging slightly to intersect at the object. If this is done, lenses may be added without concern for internal reflections.

### FIBEROPTIC INFORMATION

**IT13S:** individual assembly, .06 in. (1.5mm) diameter fiber bundle

**IT23S:** individual assembly, .12 in. (3mm) diameter fiber bundle

**BT13S:** bifurcated assembly, .06 in. (1.5mm) diameter fiber bundle

**BT23S:** bifurcated assembly, .12 in. (3mm) diameter fiber bundle

**L9:** .5in. (12mm) dia. lens

**L16F:** 1.0 in. (25mm) dia. lens

For more information about Banner glass fiber optic assemblies, see the Banner product catalog.

### Opposed mode

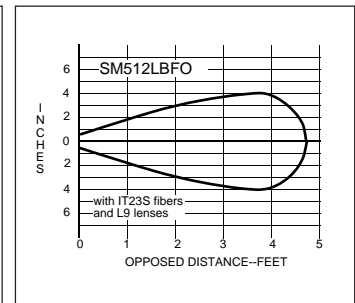
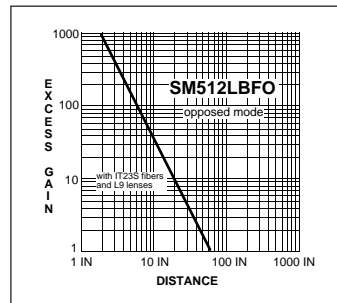
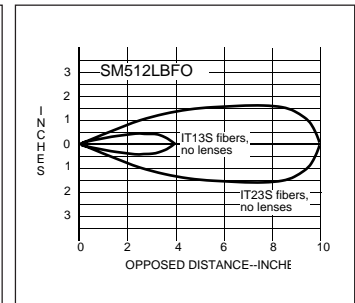
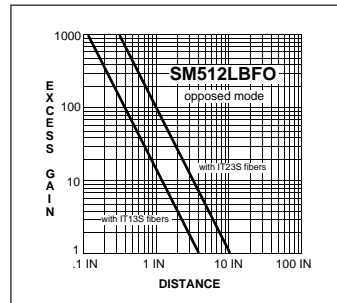
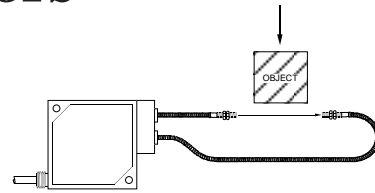

### Retroreflective mode

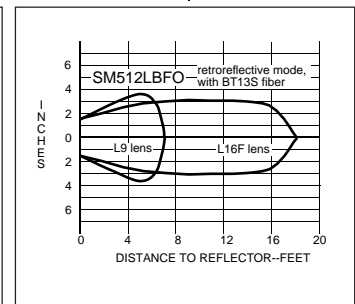
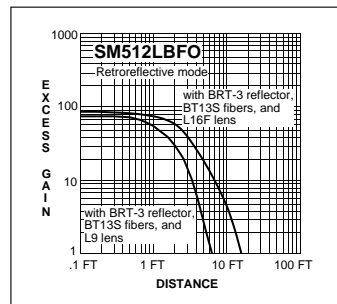
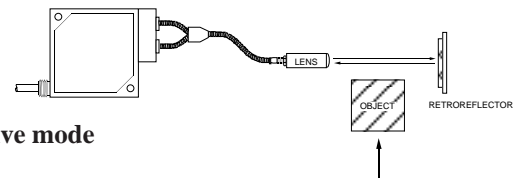

### Diffuse mode

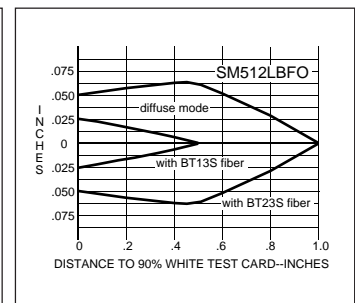
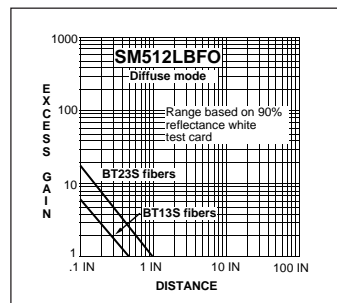
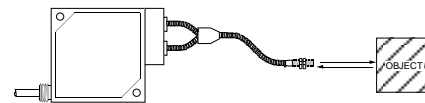

# SM512LBFO Fiber Optic Sensors

## Hookup Diagrams

### Hookup of SM512LBFO Sensor to Relay or Solenoid

SM512LBFO sensors offer two open collector NPN outputs in a complementary configuration (one normally open and one normally closed). The green output wire switches the load when the receiver "sees" its modulated light source (LIGHT operate). The white output wire switches in the dark condition (DARK operate). Both output circuits can switch up to 1/4 amp.

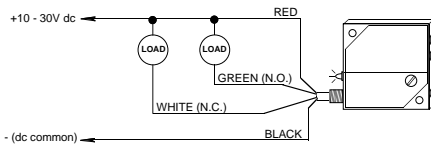

### Hookup of SM512LBFO Sensor to Counter

Most counters, totalizers, rate meters, etc. accept either output of the SM512s. Hookup to a battery-powered LCD type is shown here. For other types, follow the counter's hookup instructions for an NPN or current sinking input device.

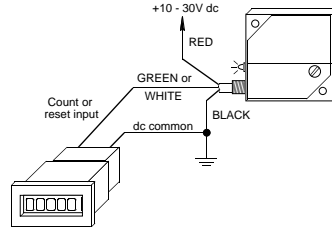

### Hookup to MICRO-AMP Logic (MPS-15 Chassis)

The output (green or white wire) of SM512 Series sensors connects directly to any input of Banner MICRO-AMP logic-only modules. These MICRO-AMP logic modules may be used:

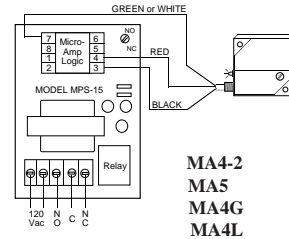

- MA4-2 One-shot
- MA5 Delay
- MA4G 4-input "AND"
- MA4L Latch

### Hookup of SM512LBFO Sensor to Programmable Controller requiring current sink

Either sensor output is wired directly to any input of the PLC. Also, connect the negative of the sensor power supply to the negative of the PLC (input card) power supply (if they are separate supplies).

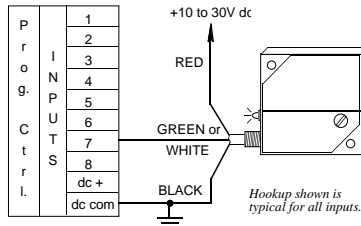

### Hookup of SM512LBFO Sensor to Programmable Controller requiring current source

Either sensor output is wired to any input of the PLC. An external "pullup" resistor is connected between the input and +V of the PLC (input card) power supply. The value of the resistor is not critical: values from 1KΩ to 10KΩ, 1/4 watt or larger, will satisfy most inputs. Also, connect the negative of the sensor power supply to the negative of the PLC (input card) power supply (if they are separate supplies).

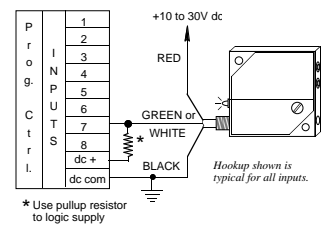

\* Use pullup resistor to logic supply

### Hookup to MAXI-AMP Logic (CL Series modules)

The output of an SM512LBFO sensor may be used as an input to Banner MAXI-AMP CL Series logic modules. The MAXI-AMP, when powered by AC voltage, offers a DC supply with enough capacity to power one SM512LBFO sensor. An SM512LBFO may also be used as an input to the auxiliary input of a CL5 module.

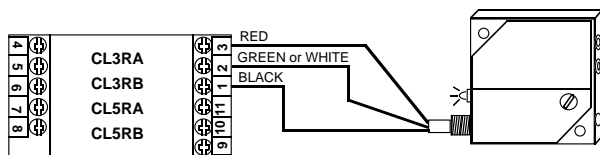

## Modification Information for SM512LBFO Sensors

These modifications are available for SM512LBFO sensors. They are not stocked, but are available on a "quote" basis:

#### HIGH SPEED Modification (model Suffix "MHS")

SM512LBFO sensors with normal response speed of 1 millisecond may be modified for faster response. Modification "MHS" offers 300 microsecond (0.3 millisecond) on and off response time. This modification is most often used on fiberoptic sensor models when

very small targets must be sensed. Repeatability of "MHS" models is 0.1 millisecond.

#### CABLE LENGTH Modification (30-foot cable)

SM512LBFO sensors may be built with a cable longer than the standard 6-foot length. The most readily available length is 30 feet. Lengths longer than 30 feet may also be quoted.

# SM512LBFO Fiber Optic Sensors

## Accessories and Modifications for SM512LBFO Sensors

**SMB500**

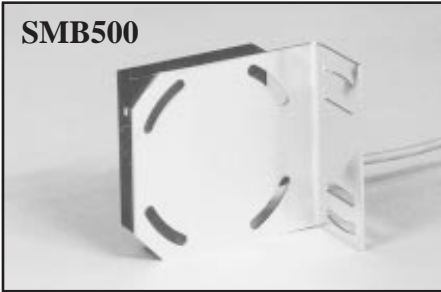

Universal steel mounting bracket for 512 Series sensors permits adjustment in both axes. Also available in stainless steel (order model SMB500SS).

**CF7-16**



Aluminum compression fitting for the cable entrance at the rear of the 512 Series sensors. May be used with either plastic or flexible steel conduit (PVC-6 or AC-6).

**FOF500**

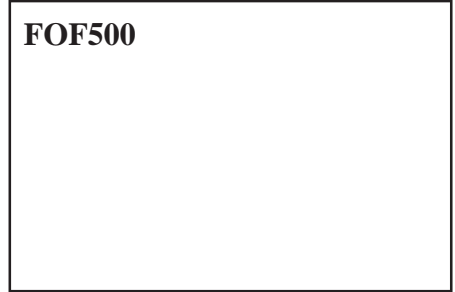

Fiberoptic interface block. Replacement item for SM512LBFO.

**AC-6 AC-30**

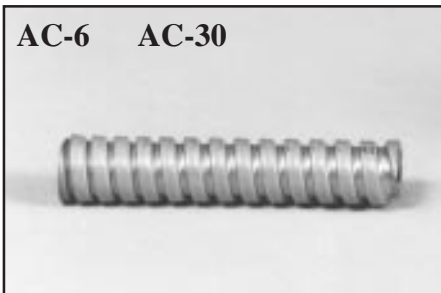

These are 6 and 30-foot lengths of flexible steel conduit and may be used with any of the 512 Series sensors and the CF7-16 fitting to provide protection to the sensor cable. Size: I.D. = 5/16"; O.D. = 7/16".

**PVC-6 PVC-30**

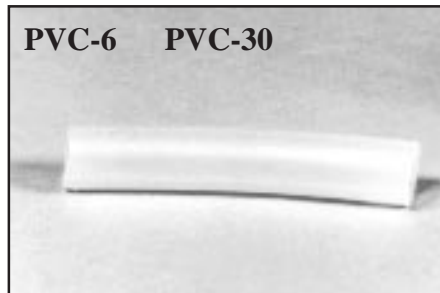

These are 6 and 30-foot lengths of plastic (PVC) flexible tubing for use with the 512 Series sensors and the CF7-16 in food applications where flexible steel conduit is not allowed. Size: I.D. = 1/4"; O.D. = 3/8".

**WARRANTY:** Banner Engineering Corporation warrants its products to be free from defects for one year. Banner Engineering Corporation will repair or replace, free of charge, any product of its manufacture found to be defective at the time it is returned to the factory during the warranty period. This warranty does not cover damage or liability for the improper application of Banner products. This warranty is in lieu of any other warranty either expressed or implied.